

ATS-STFIN-09-R0

Advanced Thermal Solutions, Inc
PROPRIETARY

NOTES:
1. TOLERANCES X.X +/- 0.50 MM, X.XX +/- 0.25 MM, X.XXX +/- 0.125 MM UNLESS SHOWN OTHERWISE.
2. SUPPLIER CERTIFIES PRODUCT IS ROHS COMPLIANT.

REVISIONS		
REV.	DESCRIPTION	DATE
R0	ORIGINAL DESIGN	06/10/14

NOT APPROVED

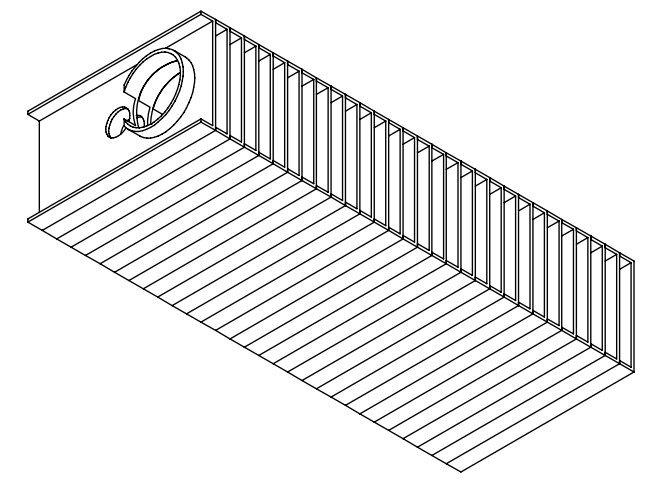
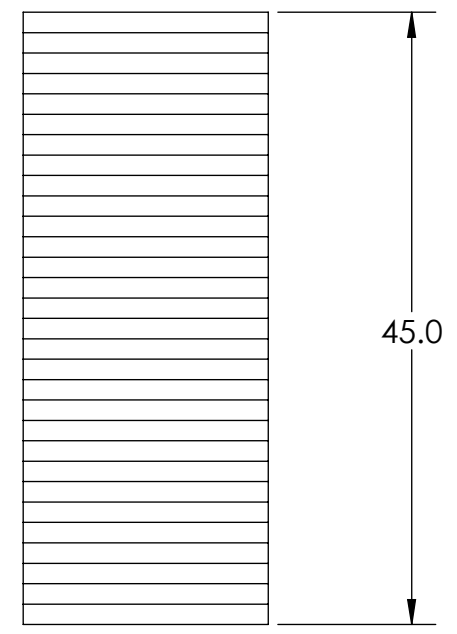
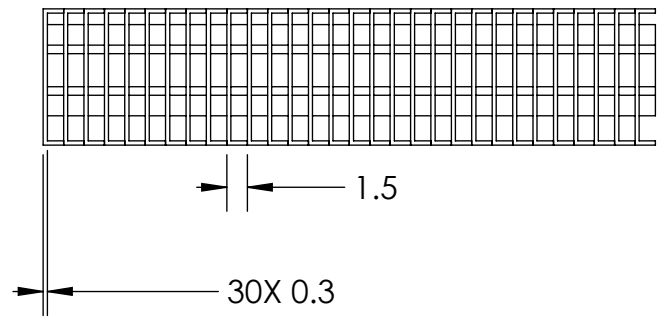
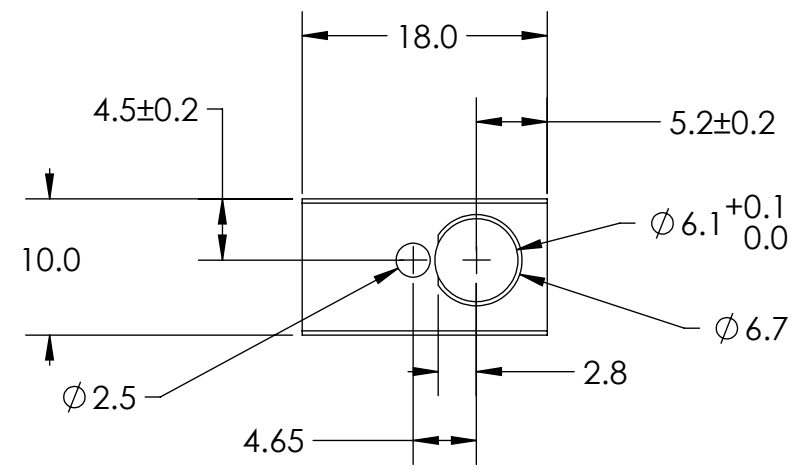

This confidential document is the sole property of Advanced Thermal Solutions (ATS). It is prohibited to reproduce or distribute this information, in whole or part, to other parties without the prior written consent of ATS.

	Advanced Thermal Solutions, Inc 89 Access Road #27 Norwood MA, 02062	DWN: CAH	DESIGNER: CAH	APPROVED /RELEASED FOR ATS MANUFACTURE:	SCALE: NTS	DATE: 6/10/2014	DWG. NO. ATS-STFIN-09-R0	LEVEL --
		DESCRIPTION: ZIPPER FIN HEAT SINK			TOLERANCE: AS SPECIFIED	FINISH: NICKEL PLATED	MATERIAL: ALUMINUM 6063	DRW UNITS: MM(IN)

THE DRAWING SHOWN WITHIN IS PROTECTED BY PATENTS GRANTED TO ADVANCED THERMAL SOLUTIONS, INC.

Tuesday, June 10, 2014

ATS-STFIN-09-R0